

LICENSE AGREEMENT

Static Control Components, Inc. (Static Control®) grants this limited license to the person, firm or corporation (hereinafter "User") downloading electronically or by printing this file to use Static Control's copyrighted documents in accordance with the terms of this agreement. If you agree with the terms of the license then you may download this information. If you do not agree with the terms of the license, then you are not authorized to use this information, and any use of it may be in violation of Static Control's copyrights or trademarks.

TRADEMARKS

The Static Control material herein may make reference to its own trademarks, or trademarks of others. Static Control grants a limited license to the User to use Static Control's trademarks in its internal documents and for its internal purposes on the following terms and conditions. Any use of Static Control's trademark must be used in a context which makes it clear that the product reference is a Static Control Components, Inc. product, and not a product from any source. The materials provided to the User may include reference to trademarks of others. Any use of the User makes of these marks should reference the owner of those marks. Nothing in this agreement constitutes any authorization by Static Control to use any of these trademarks in any context.

COPYRIGHTS

Static Control grants a limited license to the User to use the attached copyrighted documents. The permitted use of these documents is limited to internal purposes and needs of the company. The company is prohibited from using these copyrighted documents, or any part of them, including graphic elements, in any materials that are used outside the physical business location of the User. The User is prohibited from using any materials in any documents whether printed or electronic, which are distributed to any third party. The use of these copyrighted documents, or parts of them, including graphic elements, from these documents in marketing material, either print, electronic or web is prohibited. The sale, transfer, copying of these documents or any parts of these documents to any other party is prohibited.

Static Control Components, Inc. retains all rights to its copyrighted documents, and any use of these documents by User should reference Static Control's copyrights, with the notice "copyright Static Control Components, Inc."

Static Control reserves the right to cancel this license on 30-days written notice. All of the User's material incorporating Static Control's copyrighted documents shall be destroyed upon receipt of its notice of termination.

The User may not distribute, share, and otherwise convey the copyrighted documents to any other persons, corporations or individuals.

The User, by use of these documents, acknowledges Static Control's copyright in these materials.

STATIC CONTROL DOES NOT GUARANTEE OR WARRANT DOWNLOADED INFORMATION

The information User is downloading is published by Static Control in "as is" condition "with all faults". Static Control makes no representations or warranties of any kind concerning the quality, safety, or suitability of the downloadable materials, either express or implied, including without limitation any implied warranties of merchantability, fitness for a particular purpose, or non-infringement. Further, Static Control makes no representations or warranties as to the truth, accuracy or completeness of any statements, information or materials concerning items available for download. In no event will Static Control be liable for any indirect, punitive, special, incidental, or consequential damages however they may arise even if Static Control has been previously advised of the possibility of such damages.

Samsung® ML-1750

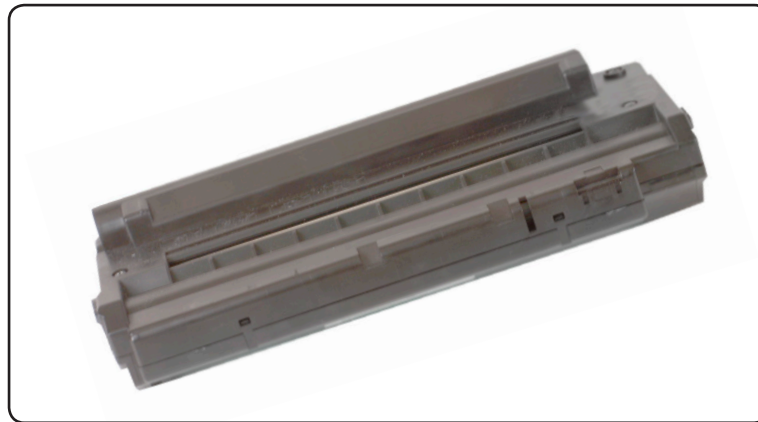

**Samsung® ML-1510/1710/1750, SCX 4216, SCX 4300;
Lexmark® X215; Xerox® Phaser® 3116 / Fuji-Xerox® Phaser® 3116;
Xerox® Phaser® 3130; Xerox® WorkCentre® PE16; Ricoh® AC-104**

SSS™ 755

TOOLS & SUPPLIES	2
SEPARATING THE COVER FROM THE DEVELOPER UNIT	4
DISASSEMBLING THE DEVELOPER UNIT ...	5
REASSEMBLING THE DEVELOPER UNIT	8
REPLACING THE COVER.....	11
ADDITIONAL INFORMATION	12

Other SSS™ documents available
in Adobe® Acrobat® PDF format.



TOOLS & SUPPLIES

- Phillips Screwdriver
- Small Slotted Screwdriver
- Needle Nose Pliers
- Compressed Air for Cleaning
- 91%-99% Isopropyl Alcohol
- Lint-Free Foam Tip Swab (LFSWAB)
- Lint-Free Cleaning Cloth (LFCLOTH)
- Felt Foam Scraper (FSTOOL)
- Curved Scraper Blade Tool (CSBTOOL)
- Blade Installation Tool (IBMSBTOOL)
- Putty (IBMDBPUTTY)
- Cotton-Tipped Swab (QTIP)



Standard Phillips Screwdriver



Small Slotted Screwdriver

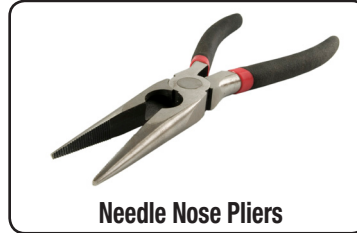

Needle Nose Pliers



Compressed Air



**91-99%
Isopropyl
Alcohol**



Lint-Free Foam Tip Swab (LFSWAB)



Felt Foam Scraper (FSTOOL)



**Curved Scraper Blade
Tool (CSBTOOL)**



Putty (IBMDBPUTTY)



Cotton-Tipped Swab (QTIP)

DEVELOPER UNIT ASSEMBLY

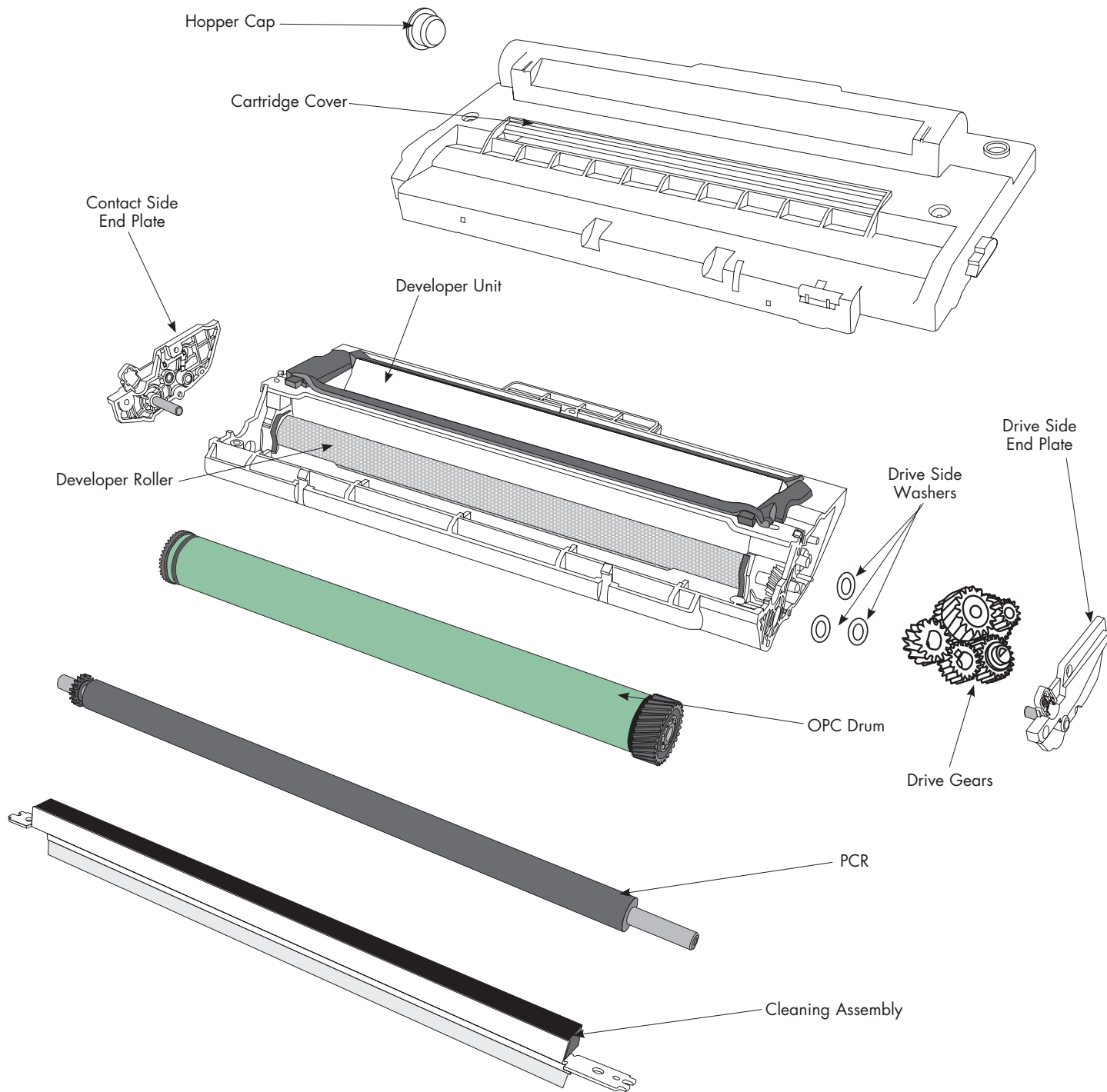

Separating the Cover from the Developer Unit

1. Remove the five screws from the top of the cartridge (Figure 1).

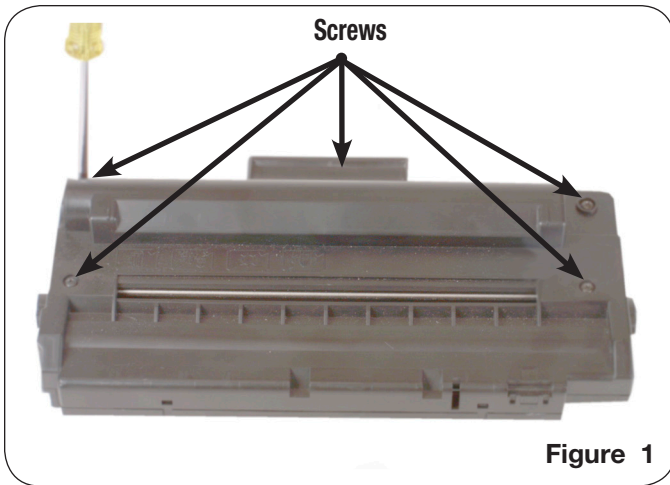

2. Using a small slotted screwdriver, release the four locking tabs (two in the front and two in the back) that secure the two sections together, as shown in Figure 2a and 2b.

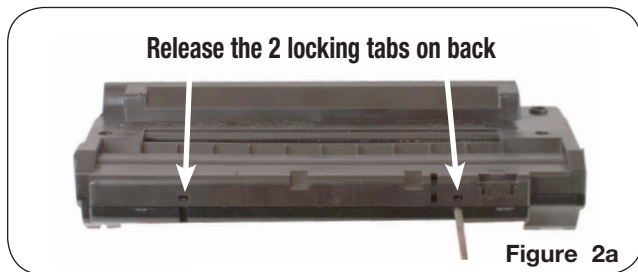

3. Remove the top of the cartridge, be careful not to spill the remaining toner from the cartridge; As shown in Figure 3.

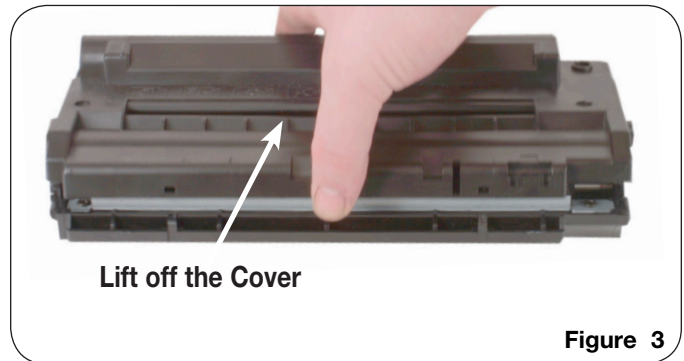

Disassembling the Developer Unit

1. Dump remaining toner from the developer unit and blow out with clean, dry, filtered compressed air.
2. Using a Phillips screwdriver, remove the three screws from the contact side end plate (Figure 4).

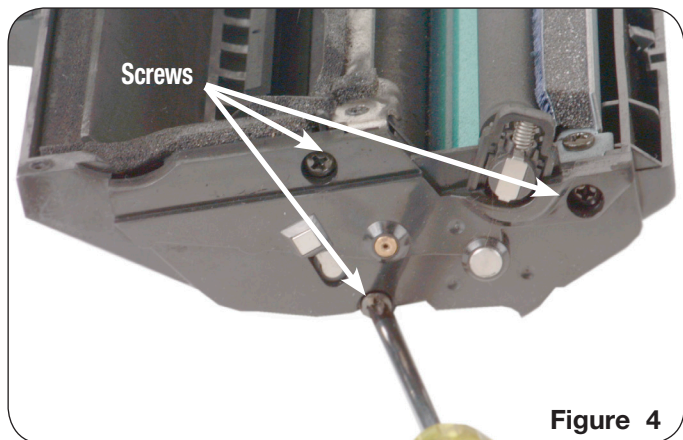

3. Remove the contact side end plate from the cartridge.
4. Using a Phillips screwdriver, remove the three screws from the drive side end plate (Figure 5).

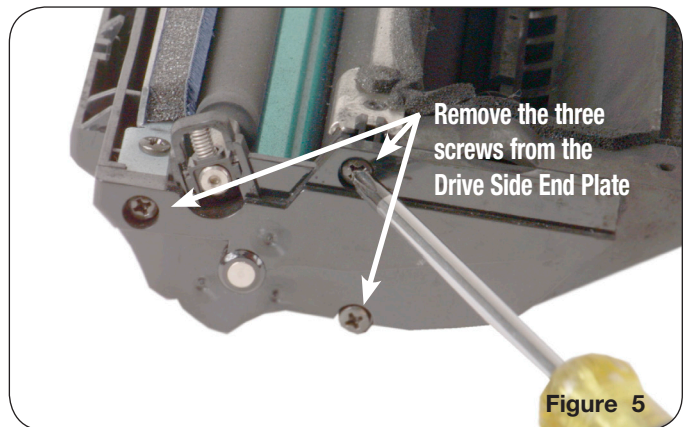

5. Remove the drive side end plate from the cartridge.

6. Grasp the PCR by the metal shafts and lift from the cartridge (Figure 6).

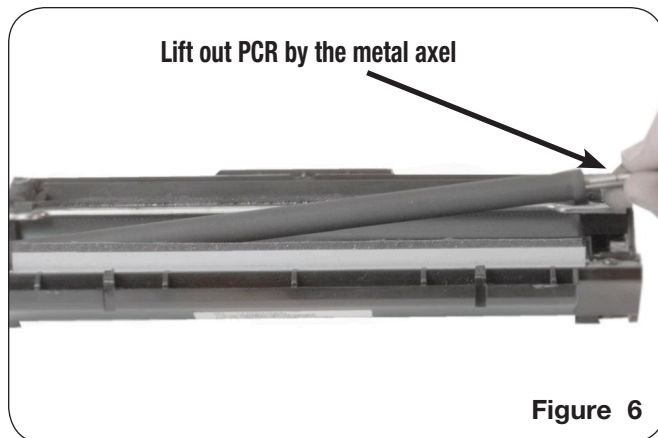

7. Clean the PCR with a lint free cloth dampened with distilled water, and place on a dry, lint free cloth. Replace if necessary.
8. First, remove the two Phillips screws from the cleaning assembly. Next, lift the cleaning assembly from the cartridge by the metal ends (Figure 7).



Note: Sometimes, the cleaning assembly is secured with only one screw.

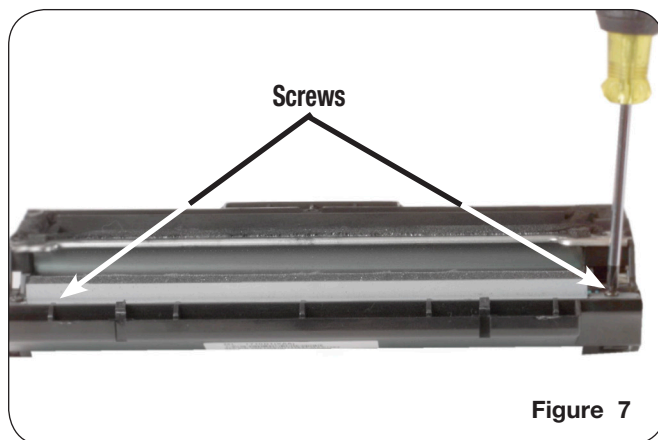

9. Blow the cleaning assembly with dry filtered compressed air and wipe the blade of the cleaning assembly with a dry, lint free cloth.

DISASSEMBLING THE DEVELOPER UNIT

10. Grasp the OPC drum by the helical ("diagonal" teeth) gear and lift out of the cartridge (Figure 8).

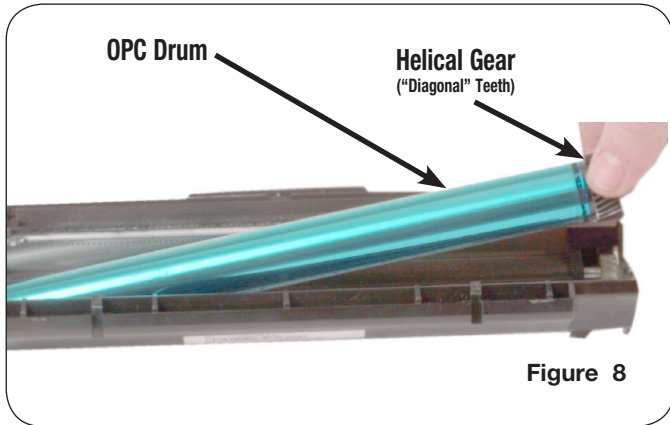

11. Remove the five gears from the drive side of the developer unit (Figure 9).

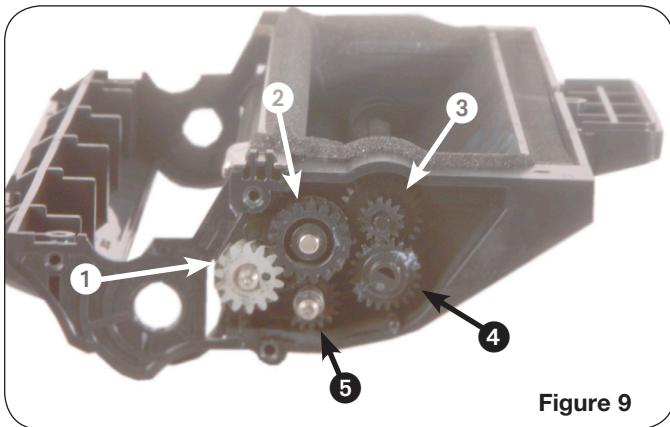

12. Note which washer was under what gear and remove them (Figure 10).

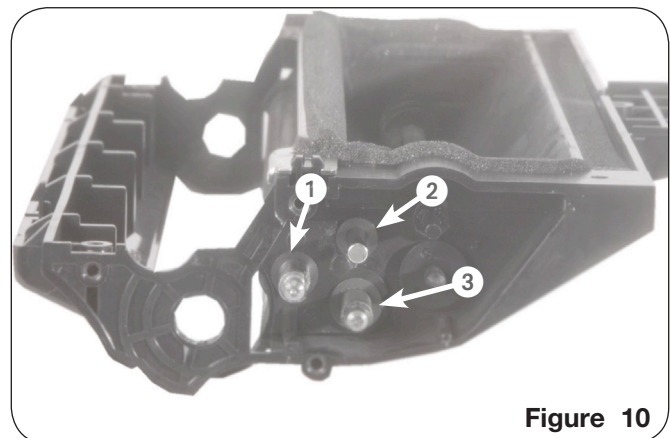

13. Clean the developer unit and the end plates with dry, filtered compressed air (Figure 11).

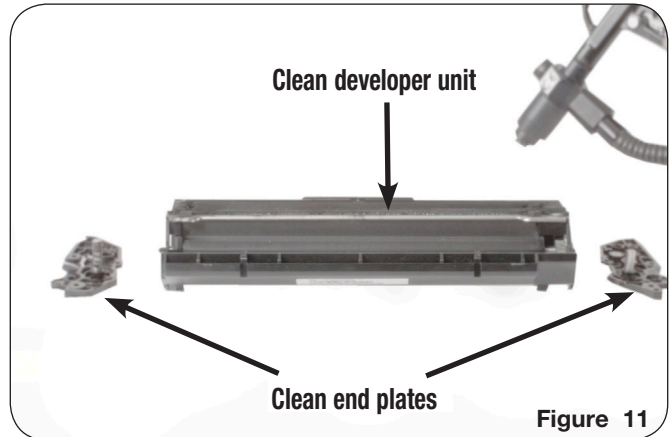

14. Using a small slotted screwdriver, release the bottom locking tab on the developer roller plate (Figure 12).

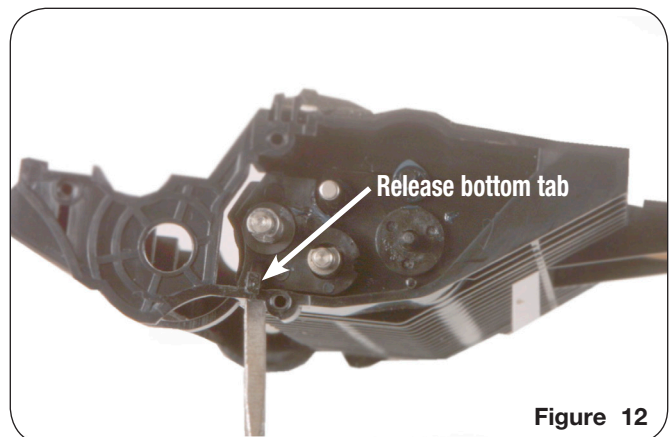

15. Using a small slotted screwdriver, release the locking tab on the top of the developer roller plate (Figure 13).

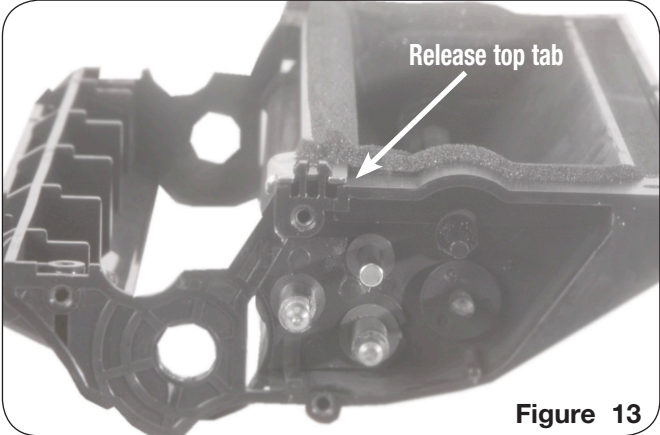

16. Grasp the metal shaft of the developer roller and slide the developer roller and the plate out of the developer unit (Figure 14).

 **Note:** Be sure not to damage or lose the teflon and mylar washers on each end of the developer roller if replacing the developer roller.

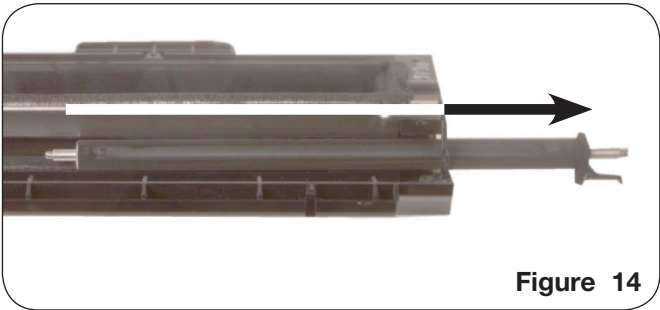

17. Clean the adder roller with dry, filtered compressed air.

18. Inspect the developer roller sealing blade for wear, rips, waves or kinks. If damaged, remove the developer roller sealing blade by using needle nose pliers to slowly peel the developer roller sealing blade from the developer unit (Figure 15). If replacing the doctor blade, remove the doctor blade before removing the developer roller sealing blade.

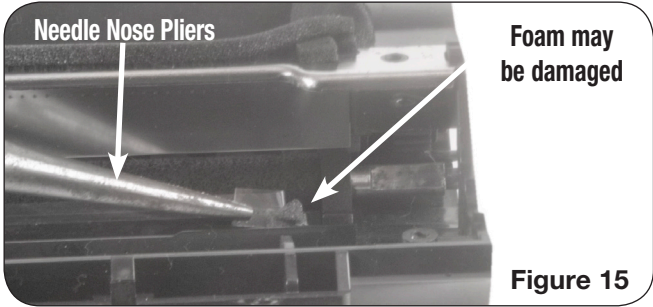

 **Note:** Two small foams lie behind the sealing blade. If they are damaged during blade removal, they will need to be replaced with putty.

 **Note:** For instructions on replacing the doctor blade, felts and foams, please refer to SSS™ #760.

Reassembling the Developer Unit

1. Using a cotton swab, clean the bushings and contacts with 91-99% Isopropyl alcohol (Figure 16).

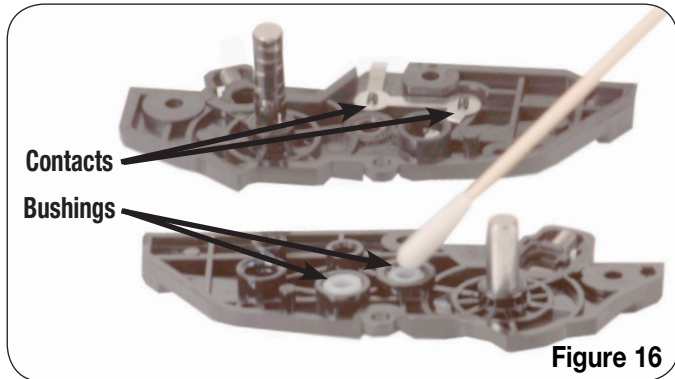

2. Using a lint-free foam-tipped swab, apply conductive lubricant to the drum, adder roller, and developer roller contacts; as well as the PCR saddle (Figures 17a and 17b).

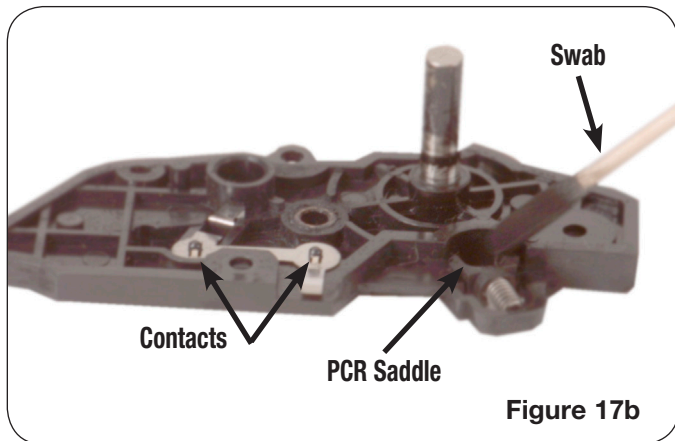
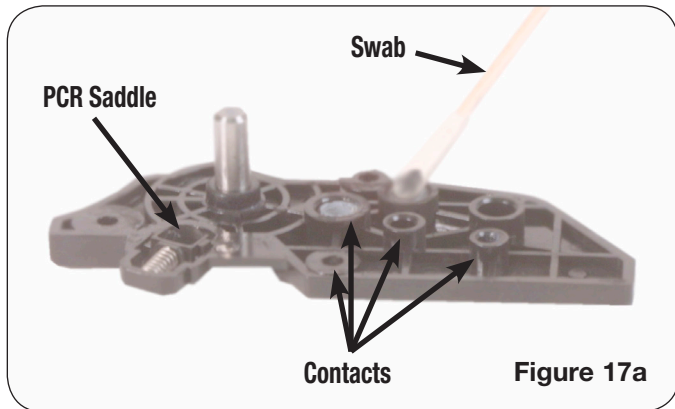

3. Use a cotton swab dampened with 91-99% Isopropyl alcohol, to clean the sealing blade mounting surface
4. If the developer roller sealing blade was removed and the foams in the developer unit were damaged, then fill the gap where foam was removed with a small amount of putty. Use only enough putty to fill the gap (Figures 18a & 18b).

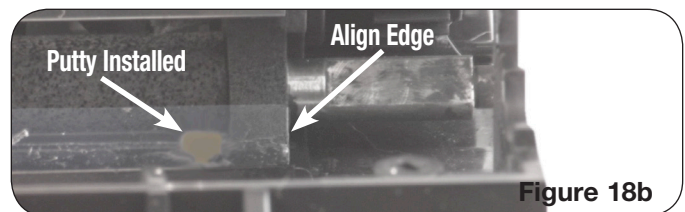
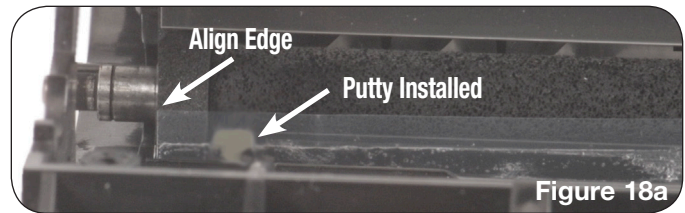

5. If replacing the developer roller sealing blade, use the blade installation tool to align the edges of the blade with the edges of the mounting surface, as shown in Figures 18a and 18b.
6. Attach the Developer Roller plate to the Developer Roller and slide into the Developer Unit as shown in Figure 19a. Secure the Developer Roller Plate by ensuring that the tabs on the top and bottom snap into place, see Figure 19b.

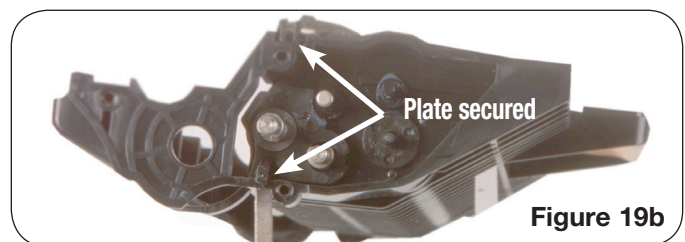
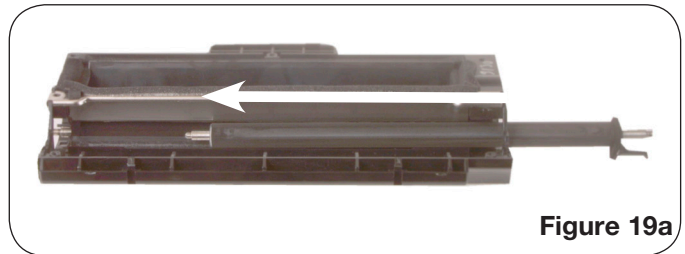

7. Install the three washers into place, as shown in Figure 20a, and apply Lubriplate #105 to the gear shafts. Install the five gears into the drive side in the order shown in Figure 20b.

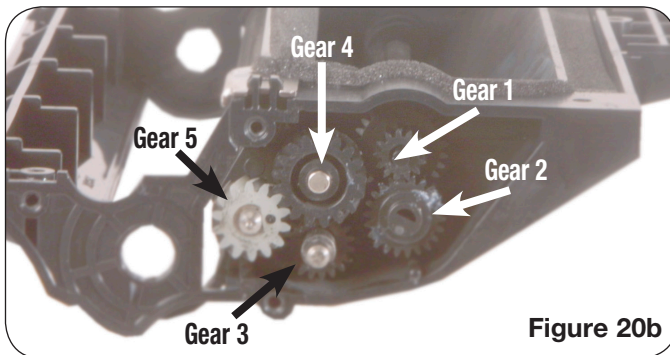
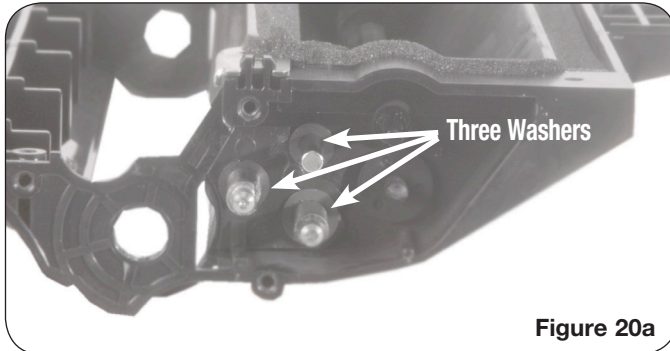

8. Grasping the drum by the gears, gently place the drum into the developer unit, as shown in Figure 21.

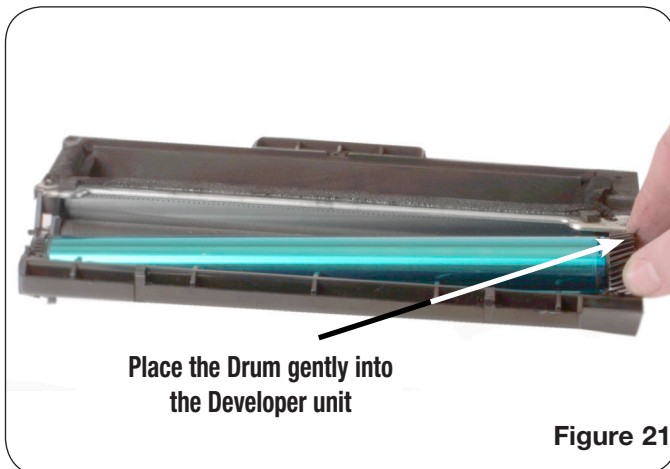

9. Place the cleaning assembly and secure with screws (Figure 22).

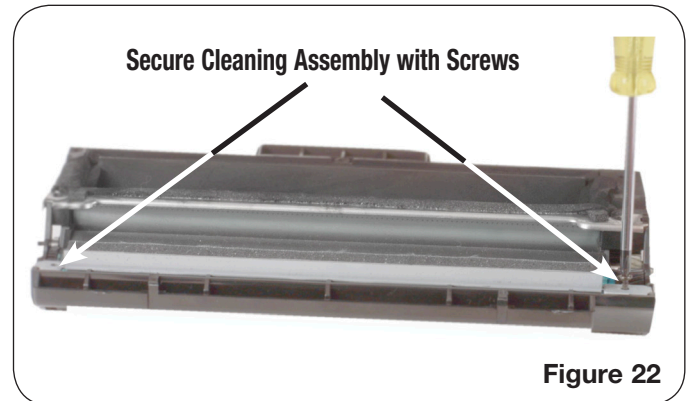

10. Attach the Contact Side End Plate, and secure with three phillips screws as shown in Figure 23.

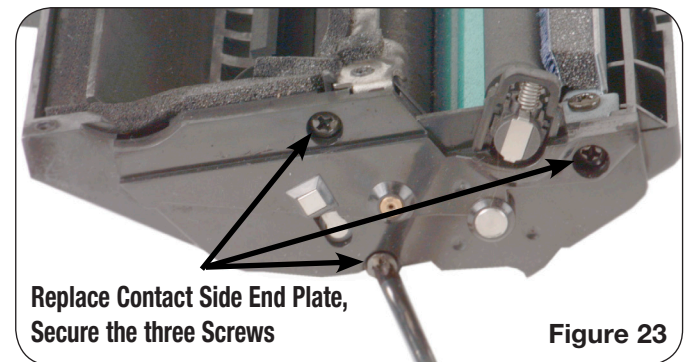

11. Grasp the PCR by the metal shafts and place into the developer unit, as shown in Figure 24.



Note: When installing the PCR be sure to align the gear on the PCR with the gear on the contact side of the drum. Also be sure to fit the PCR shafts into the saddles on each end plate.

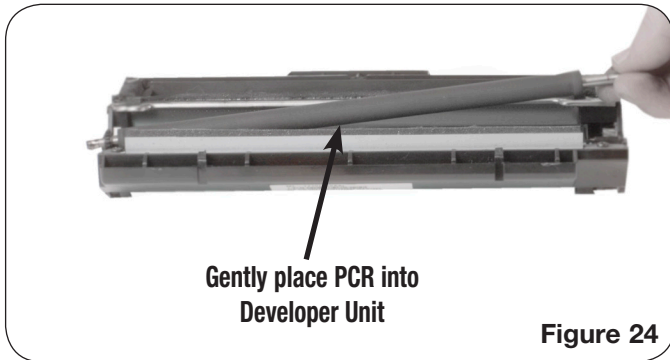

12. Attach the drive side end plate, to the developer unit and secure with three screws, as shown in Figure 25.

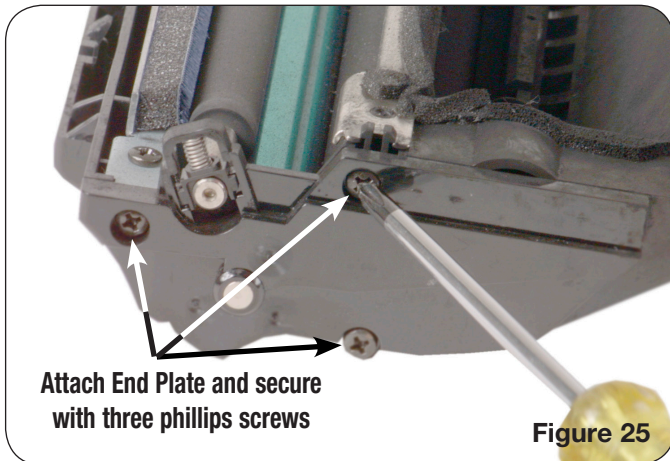

Replacing the Cover



Note: If the cartridge uses a chip, then refer to SSS™ 857 for chip installation instructions.

1. Push the hopper cap out of the cover before attaching the cover to the developer unit.
2. Place the cover of the cartridge onto the developer unit and secure with the five screws, see Figure 26. Be sure that each locking tab is latched before screws are installed.

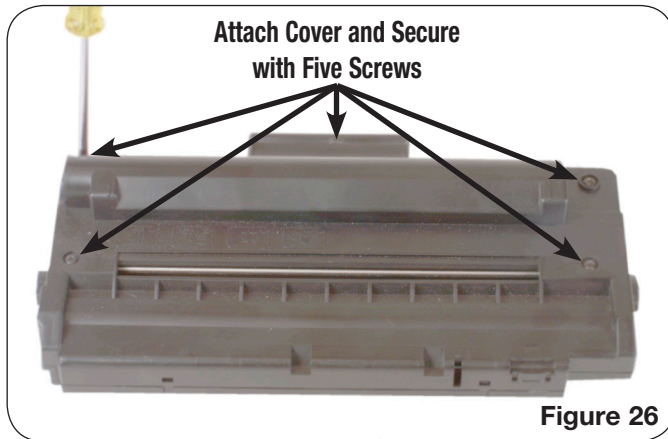

3. Fill the cartridge with toner and install the hopper cap, as shown in Figure 27.

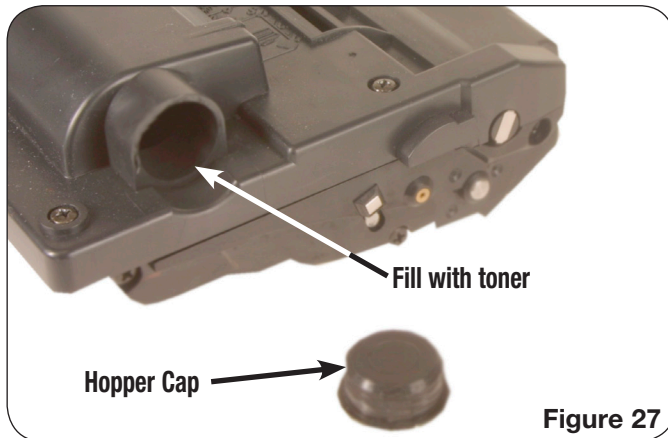

Note: If the cartridge uses a fuse, then refer to SSS™ 663 for fuse installation instructions.

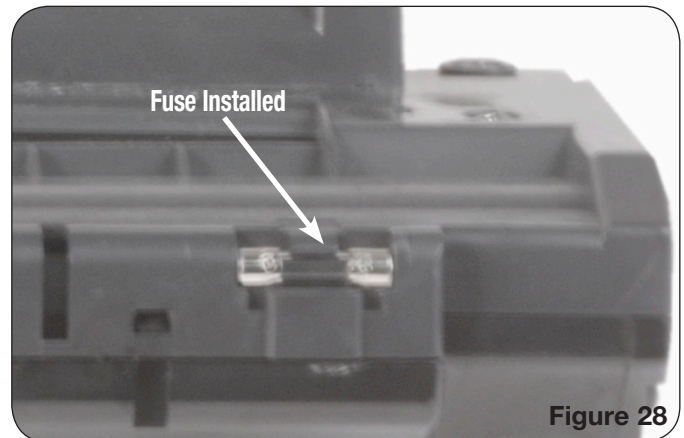

Use of Compressed Air

As of April 28, 1971, the Occupational Safety & Health Administration (OSHA) Standard, 29 CFR 1910.242 paragraphs a & b for general industry requires effective chip guarding and personal protective equipment (PPE) when using compressed air. When cleaning residual toner particles from cartridges using a compressed air system, you must use air nozzles meeting OSHA requirements. Air nozzles that regulate air pressure to a maximum of 30 psi comply with this standard. Refer to the OSHA publication for any updates or changes that have occurred since the date noted above.

Use of Isopropyl Alcohol

For best results 91-99% isopropyl alcohol should be used for cleaning as directed in this instruction. 91% isopropyl alcohol is available at most major drug stores; 99% isopropyl alcohol is available through distributors of chemical products. Follow the alcohol manufacturer's safety instructions.

Illustrations

The illustrations and photos in this document might differ slightly from your cartridge. Every effort is made to include the most up to date photos and illustrations at the time of printing. However, the OEM may make changes which were not available at the time of printing.

Safety Information

- Always wear eye protection while operating power tools.
- Always wear eye protection and protective clothing while working with toner and or other chemicals.
- Do not swallow or ingest toner, isopropyl alcohol, toner dust, or any chemicals or materials used in the process of remanufacturing.

MOVING AT THE SPEED OF NEW TECHNOLOGY

The development of cartridge imaging products and technology is the primary mission of our Imaging Labs. Through extensive testing and research, we develop the optimum combination of matched components for each cartridge. Our engineering and manufacturing expertise provides us with total control in design, quality and development to produce products from the ground up. The results are components that seamlessly work with each other and with good, used OEM parts.

This dedication and commitment results in products that Static Control fully supports, allowing you to quickly attack new market opportunities with complete confidence in the reliability and performance of your cartridges.



3010 Lee Avenue • PO Box 152 • Sanford, NC 27331
US/Can 800-488-2426
US/Can Fax 800-488-2452
Int'l 919-774-3808 • Int'l Fax 919-774-1287
www.scc-inc.com

Static Control Components (Europe) Limited
Unit 30, Worton Grange
Reading • Berkshire RG2 0TG • United Kingdom
Tel +44 (0) 118 923 8800 • Fax +44 (0) 118 923 8811
www.scceurope.co.uk